



FEDERAL SIGNAL
Safety and Security Systems

Battery Charger Retrofit Kit Q860000236 for UV Cabinet

Includes UVT6048

Description and Installation Manual

Limited Warranty

This product is subject to and covered by a limited warranty, a copy of which can be found at www.fedsig.com/SSG-Warranty. A copy of this limited warranty can also be obtained by written request to Federal Signal Corporation, 2645 Federal Signal Drive, University Park, IL 60484, email to info@fedsig.com or call +1 708-534-3400.

This limited warranty is in lieu of all other warranties, express or implied, contractual or statutory, including, but not limited to the warranty of merchantability, warranty of fitness for a particular purpose and any warranty against failure of its essential purpose.



FEDERAL SIGNAL Safety and Security Systems

2645 Federal Signal Drive
University Park, Illinois 60484

www.fedsig.com

Customer Support 800-548-7229 • +1 708 534-3400

Technical Support 800-524-3021 • +1 708 534-3400

All products indicated are trademarks of Federal Signal Corporation.

All other product names or trademarks are properties of their respective owners.

Contents

Safety Messages	5
Safety Message to Installers	5
General Description	6
Introduction	6
Qualifications	6
Required Equipment.....	7
Unpacking the Kit	7
Replacing the Battery Charger in the UV Cabinet.....	9
Turning off the Power	9
Disconnecting the Wires.....	9
Removing the Charger.....	12
Installing the New Charger	13
Connecting the Wires	14
Model UVT6048 Charger Upgrade	18
Performing Charger Upgrade in Dual Cabinet UVT6048.....	18
Testing	22
Getting Service	23

Tables

Table 1 Required Tools Checklist.....	7
Table 2 UV Kit Contents (Q860000236)	7
Table 3 Charger wires description	8
Table 4 LEDs description	17

Figures

Figure 1 Tools Required	8
Figure 2 Federal Signal 24 V Charger for UV	8
Figure 3 Slide the top two batteries forward	9
Figure 4 Remove yellow fuses.....	10
Figure 5 Charger Wiring Diagram (Legacy charger).....	10
Figure 6 Remove top two batteries from the cabinet	11
Figure 7 Remove white wire on charger.....	12
Figure 8 Remove battery disconnect switch	12
Figure 9 Remove the lug nut	13
Figure 10 Mount the new charger with the disconnect switch	13
Figure 11 Connect AC power plug.....	14
Figure 12 Connect two white wires	14
Figure 13 Charger Wiring Diagram (New charger)	15
Figure 14 Temperature sense wire.....	16
Figure 15 LEDs on charger	17
Figure 16 Charger Fault Wiring Diagram.....	20

Safety Messages

⚠ WARNING

It is important to follow all instructions shipped with this product. This device is to be installed by trained personnel who are thoroughly familiar with the country electric codes and will follow these guidelines as well as local codes.

Federal Signal reserves the right to make changes to devices and specifications detailed in the manual at any time in order to improve reliability, function or design. The information in this manual has been carefully checked and is believed to be accurate; however, no responsibility is assumed for any inaccuracies.

- Electrocutation or severe personal injury can occur when performing various installation and service functions such as making electrical connections, drilling holes, or lifting equipment. Therefore only experienced electricians should install this product in accordance with national, state and any other electrical codes having jurisdiction. Perform all work under the direction of the installation or service crew safety foreman.
- The sound output of sirens is capable of causing permanent hearing damage. To prevent excessive exposure, carefully plan siren placement, post warnings and restrict access to areas near the sirens. Sirens may be operated from remote control points. Whenever possible, disconnect all siren power including batteries before working near the siren.
- After installation or service, test the siren system to confirm that it is operating properly. Test the system regularly to confirm that it will be operational in an emergency.
- If future service personnel do not have these warnings and all other instructions shipped with the equipment to refer to, the siren system may not provide the intended audible warning and service personnel may be exposed to death, permanent hearing loss, or other bodily injury. File these instructions in a safe place and refer to them periodically. Give a copy of these instructions to new recruits and trainees. Also, give a copy to anyone who is going to service or repair the sirens.

Failure to understand the capabilities and limitations of your siren system could result in permanent hearing loss, other serious injuries or death to persons too close to the sirens when you activate them or to those you need to warn. Carefully read and thoroughly understand all safety notices in this manual and all operations-related-items in all instruction manuals shipped with equipment. Thoroughly discuss all contingency plans with those responsible for warning people in your community, company, or jurisdiction.

Safety Message to Installers

⚠ WARNING

People's lives depend on your proper installation and servicing of Federal Signal products. It is important to read and follow all instructions shipped with this product and the original product. In addition, listed below are some other important safety instructions and precautions you should follow:

- You must be a properly trained technician or electrician in order to install this product.
- Wear safety glasses.
- Remove metal jewelry; for example, rings and watches. Metal could cause a short circuit.
- Make sure that every wire terminal you remove, does not touch any other wire, cabinet, or battery terminal.
- Batteries have the risk of explosion, which could result in damage and personal injury. Take precautions to prevent open flames, sparks, or electric arcs in battery area.

General Description

Introduction

This manual describes how to replace the 24 Vdc charger (120816C) in the UV battery cabinet.

The charger features a switch mode voltage/current regulator to improve efficiency and reduce heat. The charger incorporates a three-stage charge algorithm to charge two series 12 volt batteries or four batteries in a parallel series combination for 24 Vdc while minimizing gassing and maintaining the batteries at the optimum charge level.

The charger delivers a trickle charge, a bulk charge, and a float voltage. The charger incorporates a temperature sensor that limits float voltage during high temperature conditions.

The charger monitors for faults and provides the following indicators:

- If the charger has AC power and is producing charge voltage, and, if no fault is detected, the charge status output is on. See “Table 4 LEDs description” on page 17 for description.
- If the charge voltage is too high (for example, due to charger regulation failure) a fault is detected. See “Table 4 LEDs description” on page 17 for description.

If a fault is detected, the FAULT LED lights and the charge status output is off.

Features

- Three-stage charger algorithm to charge the battery while minimizing gassing for longer battery life
- Temperature compensated charge voltage
- Efficient switch mode design
- Over-temperature protection
- Status LEDs: Trickle, Bulk, Ready, and Fault
- Charger status output
- Voltage and current regulating

Qualifications

You must be a properly trained technician or electrician in order to install this product.

Required Equipment

You need the following equipment. Standard Technician's Tool Kit that includes the following.

Table 1 Required Tools Checklist

	Description
	Ratchet set with universal joint angle extension
	Ratchet extension bar, 3 or 6 inches in length
	7/16 inch socket
	3/8 inch socket
	1/8 inch flat head screwdriver
	1/4 to 1/2 inch in width flat head screwdriver
	Wire cutter
	Fastenal clear sealed crimp window butt splice connector for 22 AWG wire
	2 wire ties
	Needle nose pliers
	Crimper for butt splice connector
	Wire strippers
	Battery load tester
	Voltmeter
	Electrical tape

Unpacking the Kit

Ensure that the parts listed are included in the kit. If you are missing any parts, contact Customer Support. See Getting Service.

Table 2 UV Kit Contents (Q860000236)

Quantity	Item Number	Description
1	860000236	Federal Signal Charger for UV
1	25500365	Retrofit Manual
1	8600112-01	UV bracket assembly
1	7058050	Keps nuts for bracket assembly

NOTE: The UV bracket assembly may be needed when mounting the charger to a steel enclosure, or an older aluminum enclosure. If the mounting holes on the charger do not match up with the enclosure, attach the charger to the bracket assembly and attach the bracket assembly to the enclosure. If the bracket assembly is not needed, discard the unneeded bracket assembly and Keps nuts.

General Description

The required tool are shown below. The battery load tester and ratchet set are not pictured.

Figure 1 Tools Required

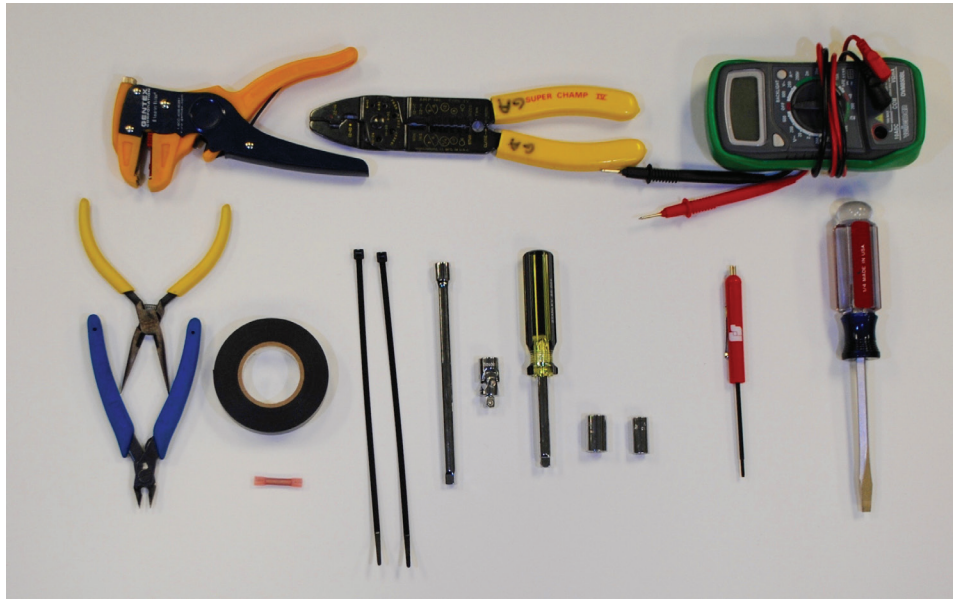

You will replace the existing charger with the following charger.

Figure 2 Federal Signal 24 V Charger for UV

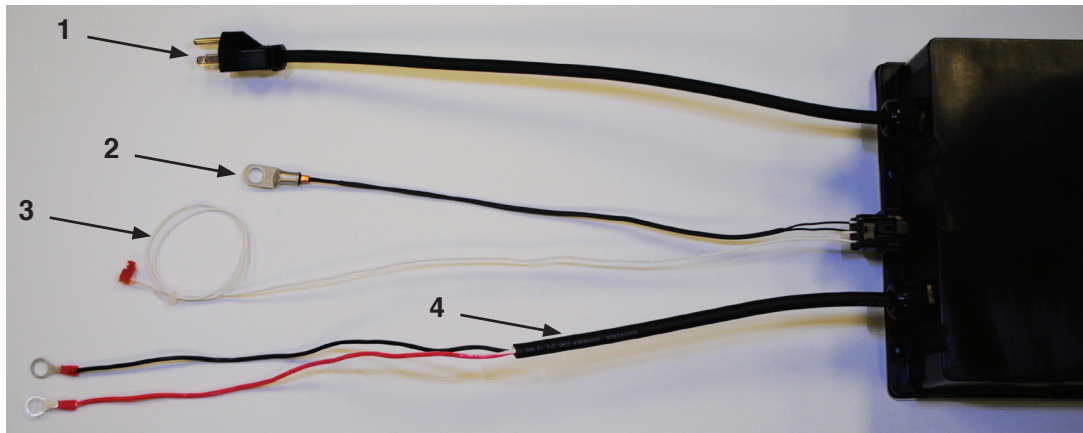

Table 3 Charger wires description

Wire number	Wire	Description
1	Black AC plug	Connects to AC power strip in cabinet.
2	Black temperature sense	Connects to Battery 2 (negative) terminal.
3	White wire	Connects to JP20 on the motherboard in the control cabinet. (Requires splicing.)
4	Black wire/Red wire	Black wire connects to Battery 1 (negative) terminal. Red wire connects to 200 A fuse.

Replacing the Battery Charger in the UV Cabinet

Before installing the new battery charger, determine the battery float voltage selection. The charger comes from the factory preset for float voltage of 13.5 Vdc per battery. This preset works with Federal Signal supplied batteries. Some batteries may recommend a different float voltage, the charger can be set from 13.2 to 13.8 Vdc per battery (actual voltage is 26.4 to 27.6 Vdc). If the battery float voltage requires adjustment, remove the cover on the charger and change the JP7 jumper to the appropriate settings.

To install the new battery charger, do the following.

Turning off the Power

1. Remove AC power to the control cabinet. Locate the AC disconnect box. Turn off the power to the cabinet. Use a voltmeter to ensure AC power is off.
2. Put the battery switch in the off position.

NOTE: Load test the batteries and replace batteries as necessary before proceeding.

Disconnecting the Wires

3. Slide the top two batteries forward to provide better access to wires.

Figure 3 Slide the top two batteries forward

Battery switch

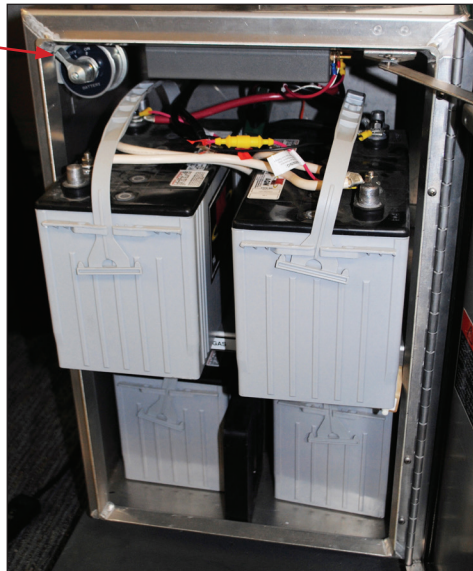

⚠ WARNING

Make sure that every wire terminal you remove, does not touch any other wire, cabinet, or battery terminal.

Replacing the Battery Charger in the UV Cabinet

- There are three fuses from the charger connected to either batteries or to the 200 A fuse. Remove all three fuses. The fuse assemblies do not require re-assembly since they will be removed.

Figure 4 Remove yellow fuses



Figure 5 Charger Wiring Diagram (Legacy charger)

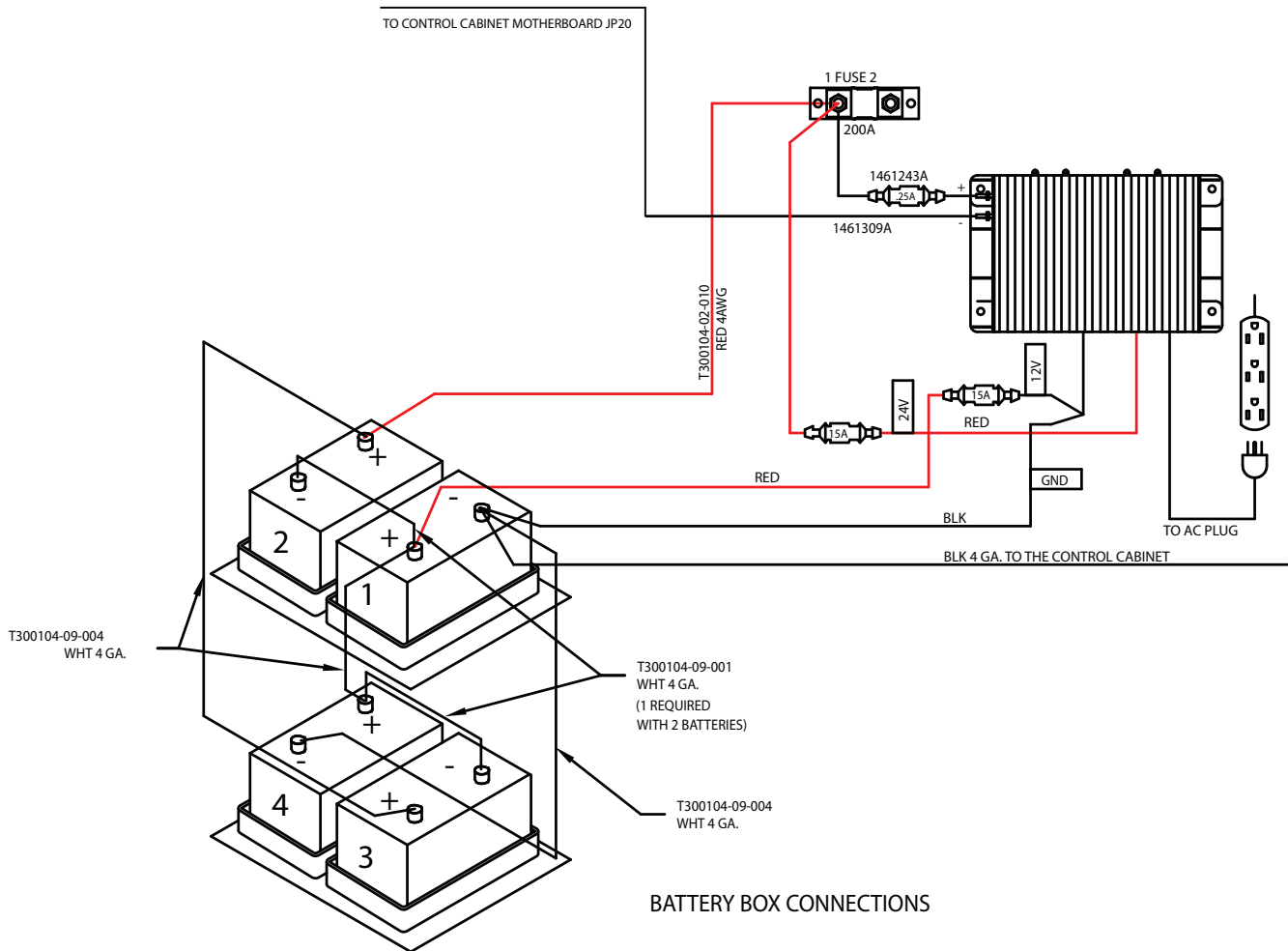

NOTE: For the complete drawing, see the UltraVoice Manual.

5. There are three wires connected to Battery 1 (negative) terminal. Remove all three wires. When you remove the white wire connected to Battery 4 (negative) terminal, wrap the terminal end with electrical tape to eliminate the possibility of shorting.
NOTE: Some battery cabinets may only have two batteries. Adjust procedure accordingly.
6. There are three wires on Battery 1 (positive) terminal. Disconnect the following wires:
 - a. Small red wire connected to Battery 1 (positive) terminal to charger. Remove from cabinet and discard.
 - b. White 4 AWG wire connected to Battery 1 (positive) terminal to Battery 2 (negative) terminal. Remove from cabinet and set aside to be reused.
 - c. White wire connected to Battery 1 (positive) terminal that is connected to Battery 4 (positive) terminal. Wrap Battery 4 (positive) terminal end with electrical tape to eliminate the possibility of shorting.
7. Remove Battery 1 from the cabinet.
8. There are two wires on Battery 2 (positive) terminal (three wires, depending on the configuration). See Figure 5. Disconnect the following wires:
 - a. If equipped, small fused red wire. Remove from cabinet and discard.
 - b. White 4 AWG wire connected to Battery 2 (positive) terminal that is connected to Battery 3 (positive) terminal. Wrap Battery 2 (positive) terminal end with electrical tape to eliminate the possibility of shorting.
 - c. Red 4 AWG wire connected to the 200 A fuse in the back of the cabinet.
9. Remove Battery 2 from the cabinet.

Figure 6 Remove top two batteries from the cabinet

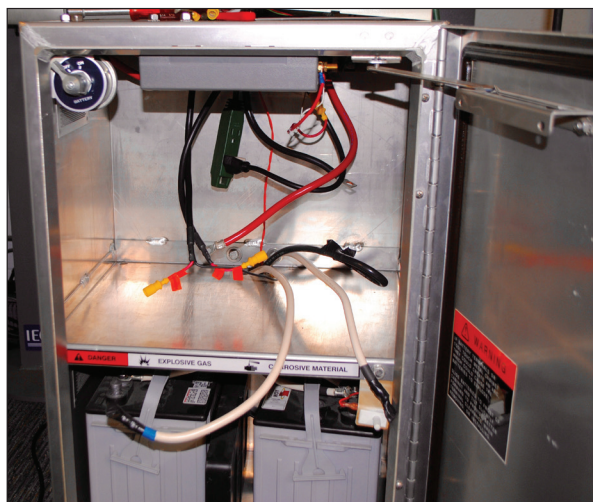

Replacing the Battery Charger in the UV Cabinet

10. Disconnect the white wire on the side of the charger by removing 3/8 inch Keps nut.

Figure 7 Remove white wire on charger

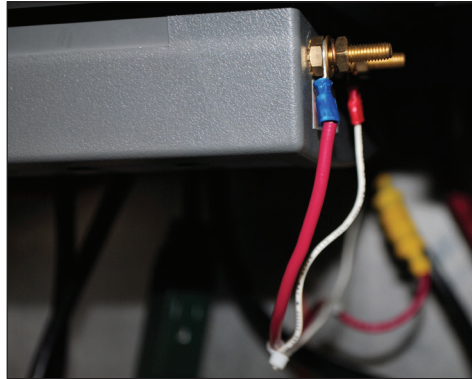

Removing the Charger

11. Use a 7/16 inch socket to remove charger. Remove the four Keps nuts on the charger and set aside. (You will reuse Keps nuts for the new charger.)
12. Remove the battery disconnect switch.

NOTE: On some models, there are another set of nuts to remove with mounting plate.

Figure 8 Remove battery disconnect switch

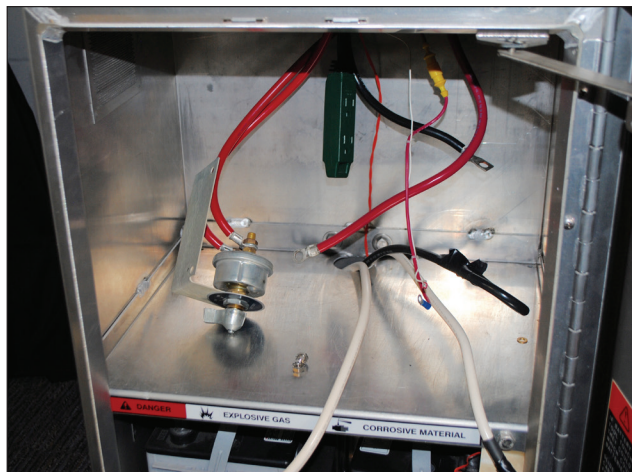

13. Disconnect the 7/16 inch Keps nut on the fuse in the back of the cabinet and take the 4 AWG wire off fuse block and set aside to be reused.

Figure 9 Remove the lug nut

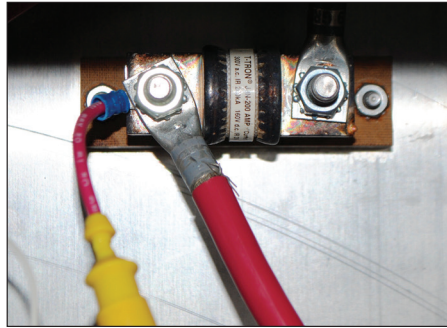

14. If equipped, cut the tie wraps off the small red wire connected to the 200 A fuse. Remove the small red wire and discard.

Installing the New Charger

15. Install the charger with the LEDs facing the front. Place the charger into the cabinet and reuse the Keps nuts from the original charger. Install in the same place as the original charger.
16. Mount the charger with the battery disconnect switch together.

Figure 10 Mount the new charger with the disconnect switch



NOTE: On some model enclosures, the charger may need to be attached to the enclosure using the included mounting plate using Keps nuts. Discard mounting plate and Keps nuts if not needed.

17. Verify that Keps nuts are tight.

Connecting the Wires

18. Connect the AC power plug from the new charger into the AC power strip.

Figure 11 Connect AC power plug



19. Identify existing thin white sensor wire coming from the upper control cabinet. (See Figure 13.)
20. In the battery cabinet, cut the connector off the thin white sensor wire and strip the insulation off the wire.
21. Identify the thin white wire on the new charger. (See Figure 2, number 3.)
22. Cut the connector off the white wire from the charger and strip the insulation off the wire.
23. Connect the two white wires using a wire connector (for example, Fastenal clear sealed crimp window butt splice connector). Lightly pull on each wire to ensure the wires are secured inside of the connector.

Figure 12 Connect two white wires

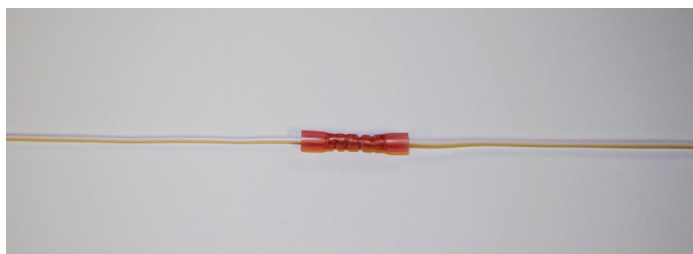

24. Secure the white sensor wire with a wire tie to keep out of the way of the batteries.
25. Attach the following two wires to the left side of the 200 A fuse:
 - a. Small red wire from the new charger.
 - b. Red 4 AWG wire. This wire will connect to Battery 2 (positive) terminal in a later step.

26. Slide Battery 2 into cabinet. Leave battery slightly forward to allow access to wires. See Figure 13 for the orientation of the batteries.

Figure 13 Charger Wiring Diagram (New charger)

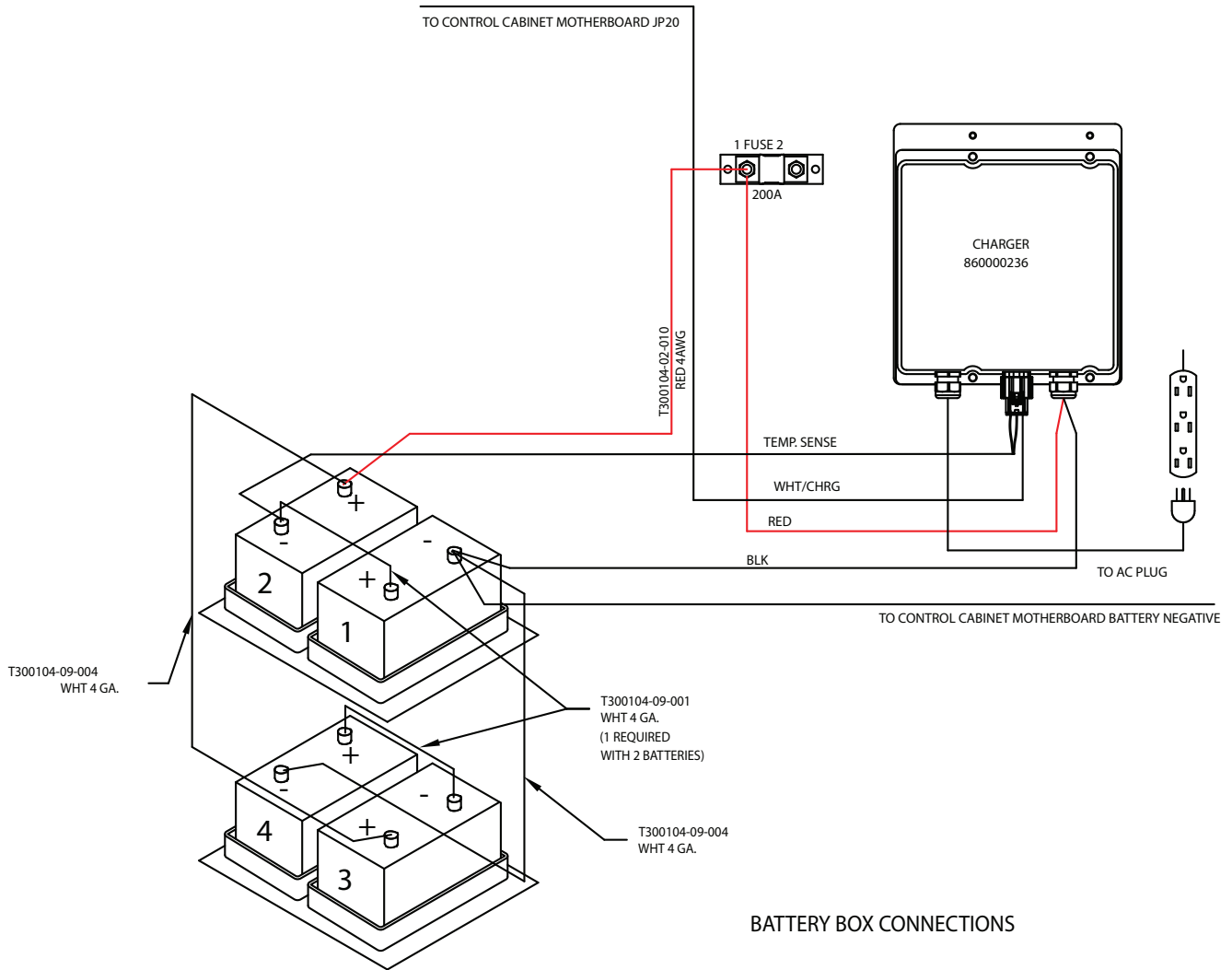

27. Connect the following two wires on Battery 2 (positive) terminal:
- Red 4 AWG wire from the 200 A fuse in the back of the cabinet.
 - White 4 AWG wire from Battery 3 (positive) terminal. Remove tape from terminal end.

28. Identify the temperature sense wire from the new charger. It is black with two wires attached to a temperature sensing ring terminal. (See Figure 15.)

Figure 14 Temperature sense wire



29. Connect the temperature sense wire from charger to Battery 2 (negative) terminal.
30. Slide Battery 1 into cabinet. Leave battery slightly forward to allow access to wires.
31. Connect the following two wires on Battery 1 (positive) terminal:
 - a. White 4 AWG wire from Battery 1 (positive) terminal to Battery 2 (negative) terminal.
 - b. White 4 AWG wire from Battery 4 (positive) terminal. Remove tape from terminal end.
32. Connect the following three wires on Battery 1 (negative) terminal:
 - a. Black 4 AWG wire from control cabinet motherboard BATTERY (negative).
 - b. Black wire from new charger.
 - c. White 4 AWG wire from Battery 4 (negative) terminal. Remove tape from terminal end.
33. Verify that all battery and 200 A fuse connections are tight.
34. Slide batteries all the way back into cabinet.
35. Put the battery switch in the ON position.
36. Measure the overall battery voltage between Battery 1 (negative) and Battery 2 (positive). The battery voltage should be 25 to 27 Vdc (nominal).
37. Turn on the AC power to the control cabinet.
38. Check battery charger. The READY light should be green.

Figure 15 LEDs on charger



Table 4 LEDs description

LED	Description
CURRENT	Green LED indicates charge current is being delivered to the battery. LED intensity increases with charge current.
TRICKLE	Yellow LED indicates battery voltage is below 20 V and the charger is trickle charging at a low current level.
BULK	Yellow LED indicates battery voltage has dropped below 90% of the float voltage setting and charger is charging at a high current level.
READY	Green LED indicates battery has reached the float voltage. The charger is float charging at the float voltage setting.
FAULT	Red LED indicates a charger fault. Charger may be delivering abnormally low current or has a blown fuse or is not producing the correct output voltage.

NOTE: Battery Voltage is temperature compensated when the temperature is above 86°F (30°C).

39. Measure the overall charger voltage between Battery 1 (negative) terminal and Battery 2 (positive) terminal. Ensure the voltage is rising up to 27 Vdc (nominal).

40. Close cabinet doors.

The charger retrofit procedure is now completed. Federal Signal recommends testing the warning system prior to putting back into service.

Model UVT6048 Charger Upgrade

The following procedure is to upgrade to the new (860000236) chargers in a UV dual cabinet that supports the older MOD6048 siren. Federal Signal requires that you replace both chargers for this procedure. If one charger is not defective, it could be used in the future for replacement of the same type of charger. This procedure requires a DIN rail mounted opto-isolator (19001437A) to be mounted in the primary cabinet.

Required Hardware

Opto-isolator solid-state relay 19001437A 24V

Performing Charger Upgrade in Dual Cabinet UVT6048

To install the new battery charger, do the following.

1. Remove AC power to both control cabinets. Locate the AC disconnect box. Turn off the power to the cabinets. Use a voltmeter to ensure AC power is off.
2. Put the battery switch in the off position with both cabinets.

NOTE: Load test the batteries and replace batteries as necessary before proceeding.

3. Slide the top two batteries forward to provide better access to wires. (See Figure 3.)
4. **Primary Cabinet:** There are two fuses from the charger connected to either batteries or to the 200 A fuse. Remove both fuses. The fuse assemblies do not require re-assembly since they will be removed.

Secondary Cabinet: There are three fuses from the charger connected to either batteries or to the 200 A fuse. Remove all three fuses. The fuse assemblies do not require re-assembly since they will be removed. (See Figure 4.)

Perform the following procedure for both cabinets:

5. There are three wires connected to Battery 1 (negative) terminal. Remove all three wires. When you remove the white wire connected to Battery 4 (negative) terminal, wrap the terminal end with electrical tape to eliminate the possibility of shorting.
NOTE: Some battery cabinets may only have two batteries. Adjust procedure accordingly.
6. There are three wires on Battery 1 (positive) terminal. Disconnect the following wires:
 - a. Small red wire connected to Battery 1 (positive) terminal to charger. Remove from cabinet and discard.
 - b. White 4 AWG wire connected to Battery 1 (positive) terminal to Battery 2 (negative) terminal. Remove from cabinet and set aside to be reused.
 - c. White wire connected to Battery 1 (positive) terminal that is connected to Battery 4 (positive) terminal. Wrap Battery 4 (positive) terminal end with electrical tape to eliminate the possibility of shorting.
7. Remove Battery 1 from the cabinet.

8. There are two wires on Battery 2 (positive) terminal (three wires, depending on the configuration). See Figure 5. Disconnect the following wires:
 - a. If equipped, small fused red wire. Remove from cabinet and discard.
 - b. White 4 AWG wire connected to Battery 2 (positive) terminal that is connected to Battery 3 (positive) terminal. Wrap Battery 2 (positive) terminal end with electrical tape to eliminate the possibility of shorting.
 - c. Red 4 AWG wire connected to the 200 A fuse in the back of the cabinet.
9. Remove Battery 2 from the cabinet. (See Figure 6.)
10. **Primary Battery Cabinet:** Disconnect the two white wires on the side of the charger by removing 3/8 inch Keps nuts.
Secondary Battery Cabinet: Disconnect the white wire on the side of the charger by removing 3/8 inch Keps nut.

Perform the following procedure for both cabinets:

11. Use a 7/16 inch socket to remove charger. Remove the four Keps nuts on the charger and set aside. (You will reuse Keps nuts for the new charger.)
12. Remove the battery disconnect switch. (See Figure 8.)
NOTE: On some models, there are another set of nuts to remove with mounting plate.
13. Disconnect the 7/16 inch Keps nut on the fuse in the back of the cabinet and take the 4 AWG wire off fuse block and set aside to be reused. (See Figure 9.)
14. If equipped, cut the tie wraps off the small red wire connected to the 200 A fuse. Remove the small red wire and discard.
15. Install the charger with the LEDs facing the front. Place the charger into the cabinet and reuse the Keps nuts from the original charger. Install in the same place as the original charger.
16. Mount the charger with the battery disconnect switch together. (See Figure 10.)
NOTE: On some models, there are another set of nuts to attach to mounting plate.
17. Verify that Keps nuts are tight.
18. Connect the AC power plug from the new charger into the AC power strip. (See Figure 11.)
19. **Secondary Battery Cabinet:** Identify existing thin white sensor wire coming from the upper control cabinet. (See Figure 13.)
20. **Secondary Battery Cabinet:** In the battery cabinet, cut the connector off the thin white sensor wire and strip the insulation off the wire.

21. **Secondary Battery Cabinet:** Identify the thin white wire on the new charger. (See Figure 2, number 3.)
22. **Secondary Battery Cabinet:** Cut the connector off the white wire from the charger and strip the insulation off the wire.
23. **Secondary Battery Cabinet:** Connect the two white wires using a wire connector (for example, Fastenal clear sealed crimp window butt splice connector). Lightly pull on each wire to ensure the wires are secured inside of the connector. (See Figure 12.)
24. **Secondary Battery Cabinet:** Secure the white sensor wire with a wire tie to keep out of the way of the batteries.
25. **Primary Control Cabinet:** Mount a 19001437A opto-isolated relay to the DIN rail. The opto-isolator has connections A1, A2, 13 and 14. (See Figure 16.)

Figure 16 Charger Fault Wiring Diagram

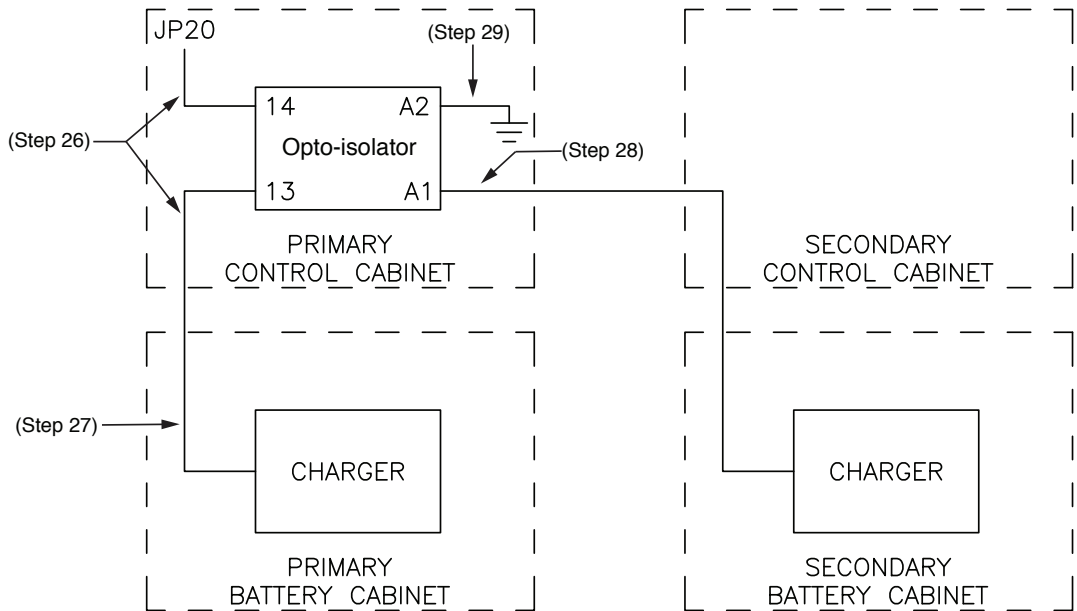

26. **Primary Control Cabinet:** Find the white sensor wire that goes from the primary control motherboard to the primary battery cabinet. In the primary control cabinet, cut this wire and connect to the opto-isolator. The white wire from the primary control backplane is connected to connection 14 on the opto-isolator. The other end of this cut wire going to the lower cabinet is connected to connection 13 on the opto-isolator.
27. **Primary Battery Cabinet:** Cut the connector off the thin white sensor wire from the primary control cabinet and strip the insulation off the wire. Identify the thin white wire on the new charger. (See Figure 2, number 3.) Cut the connector off the white wire from the charger and strip the insulation off the wire. Connect the two white wires using a wire connector (for example, Fastenal clear sealed crimp window butt splice connector). Lightly pull on each wire to ensure the wires are secured inside of the connector. Secure the white sensor wire with a wire tie to keep out of the way of the batteries.

28. **Primary Control Cabinet:** Find the white wire coming from the secondary control cabinet to the primary battery cabinet. Cut this wire and attach the wire coming from the secondary control cabinet to connection A1 on the opto-isolator.
29. **Primary Control Cabinet:** Attach a wire from ground to connection A2 on the opto-isolator.

In both battery cabinets, perform the following:

30. Attach the following two wires to the left side of the 200 A fuse:
 - a. Small red wire from the new charger.
 - b. Red 4 AWG wire. This wire will connect to Battery 2 (positive) terminal in a later step.
31. Slide battery 2 into cabinet. Leave battery slightly forward to allow access to wires. See Figure 13 for the orientation of the batteries.
32. Connect the following two wires on Battery 2 (positive) terminal:
 - a. Red 4 AWG wire from the 200 A fuse in the back of the cabinet.
 - b. White 4 AWG wire from Battery 3 (positive) terminal. Remove tape from terminal end.
33. Identify the temperature sense wire from the new charger. It is black with two wires attached to a temperature sensing ring terminal. (See Figure 14.)
34. Connect the temperature sense wire from charger to Battery 2 (negative) terminal.
35. Slide Battery 1 into cabinet. Leave battery slightly forward to allow access to wires.
36. Connect the following two wires on Battery 1 (positive) terminal:
 - a. White 4 AWG wire from Battery 1 (positive) terminal to Battery 2 (negative) terminal.
 - b. White 4 AWG wire from Battery 4 (positive) terminal. Remove tape from terminal end.
37. Connect the following three wires on Battery 1 (negative) terminal:
 - a. Black 4 AWG wire from control cabinet motherboard BATTERY (negative).
 - b. Black wire from new charger.
 - c. White 4 AWG wire from Battery 4 (negative) terminal. Remove tape from terminal end.
38. Verify that all battery and 200 A fuse connections are tight.
39. Slide batteries all the way back into cabinet.
40. Put the battery switch in the ON position.
41. Measure the overall battery voltage between Battery 1 (negative) and Battery 2 (positive). The battery voltage should be 25 to 27 Vdc (nominal).

42. Turn on the AC power to the control cabinet.
43. Check battery charger. The READY light should be green. (See Figure 15.)
44. Measure the overall charger voltage between Battery 1 (negative) terminal and Battery 2 (positive) terminal. Ensure the voltage is rising up to 27 Vdc (nominal).
45. Close cabinet doors.

The charger retrofit procedure is now completed. Federal Signal recommends testing the warning system prior to putting back into service.

Testing

⚠ WARNING

The output sound level of a siren is capable of causing severe hearing discomfort or permanent hearing damage. Therefore, always wear adequate hearing protection and minimize exposure time when performing any testing or maintenance on the siren.

Qualified personnel familiar with the siren, associated controls, and power sources being used, should perform service or maintenance.

Before servicing or maintaining, ensure that remote activation cannot occur and disconnect power to the siren and the associated control equipment.

Failure to properly test the siren system before placing into service may prevent the siren from operating in an emergency. Tests and maintenance must be performed by an experienced technician prior to using the siren system.

Review the Installation section of the siren you are working on.

Visit <http://www.fedsig.com/> for manuals. The required parts are listed in the manual and may change according to local code.

Getting Service

If you are experiencing any difficulties, contact Federal Signal Customer Support at: 800-548-7229 or 708-534-3400 extension 7511 or Technical Support at: 800-524-3021 or 708-534-3400 extension 7329 or through email at: techsupport@fedsig.com. For instruction manuals and information on related products, visit: <http://www.fedsig.com/>



FEDERAL SIGNAL
Safety and Security Systems

2645 Federal Signal Drive
University Park, Illinois 60484

www.fedsig.com

Customer Support	800-548-7229 • +1 708 534-3400
Technical Support	800-524-3021 • +1 708 534-3400